

GLASS PARTITION

GLASS FIX - H TYPE

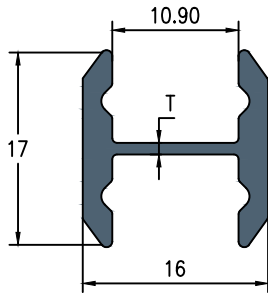

NO.	SECTION NO.	W	H	T	WEIGHT KG/12'
1	HD - 10520	16.00	17.00	2.55	0.800 - 1.000

13MM U GLASS

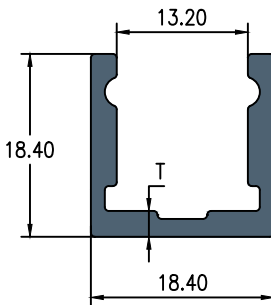

NO.	SECTION NO.	W	H	T	WEIGHT KG/12'
1	HD - 10535	18.40	18.40	2.60	1.100 - 1.300

U TYPE CLIP

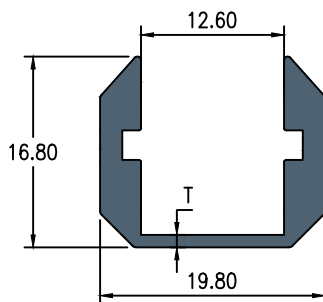

NO.	SECTION NO.	W	H	T	WEIGHT KG/12'
1	HD - 10500	19.80	16.80	1.10	1.000 - 1.200

GLASS FIX - H TYPE

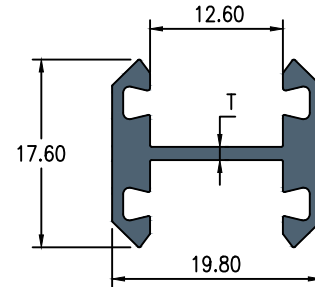

NO.	SECTION NO.	W	H	T	WEIGHT KG/12'
1	HD - 10510	19.80	17.60	1.30	1.000 - 1.200

U TYPE CLIP

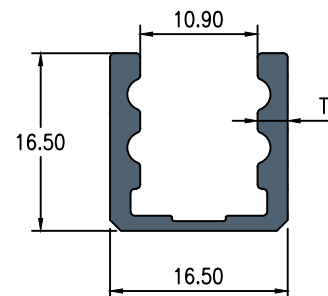

NO.	SECTION NO.	W	H	T	WEIGHT KG/12'
1	HD - 10540	16.50	16.50	2.80	0.900 - 1.000

U TYPE CLIP

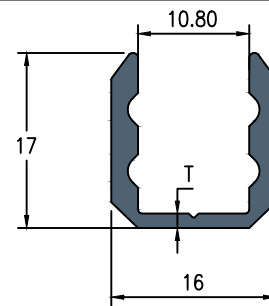

NO.	SECTION NO.	W	H	T	WEIGHT KG/12'
1	HD - 10530	16.00	17.00	1.40	0.800 - 0.900

GLASS PARTITION

I TYPE CLIP

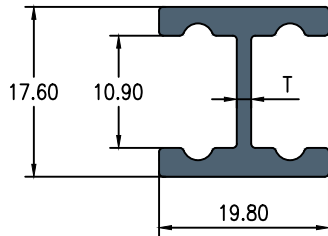

N0.	SECTION NO.	W	H	T	WEIGHT KG/12'
1	HD - 10550	16.50	16.50	1.40	0.900 - 1.000

I TYPE CLIP

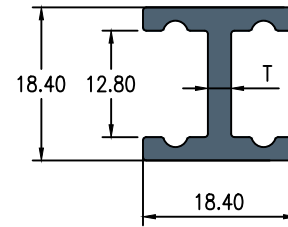

N0.	SECTION NO.	W	H	T	WEIGHT KG/12'
1	HD - 10560	18.40	18.40	2.80	1.200 - 1.300

GLASS PARTITION

VERTICAL FRAME

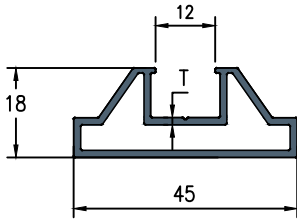

N0.	SECTION NO.	W	H	T	WEIGHT KG/12'
1	HD - 11600	45.00	18	1.42	1.800 - 2.000

INTERNAL PARTITION

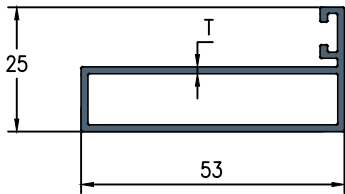

N0.	SECTION NO.	W	H	T	WEIGHT KG/12'
1	HD - 11610	53.00	25.00	1.36	2.000 - 2.200

HORIZONTAL FRAME

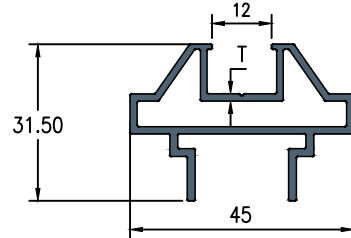

N0.	SECTION NO.	W	H	T	WEIGHT KG/12'
1	HD - 11605	45.00	18	1.42	2.300 - 2.600

VERTICAL LEG

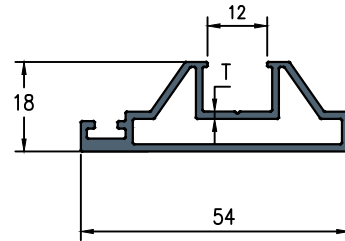

N0.	SECTION NO.	W	H	T	WEIGHT KG/12'
1	HD - 11615	54.00	18.00	1.45	2.200 - 2.400

VERTICAL FRAME

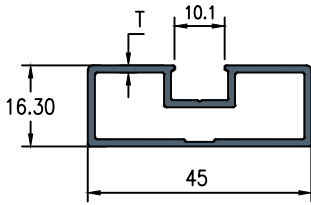

N0.	SECTION NO.	W	H	T	WEIGHT KG/12'
1	HD - 11645	45.00	16.30	1.40	1.800 - 2.000

MIDDLE FRAME

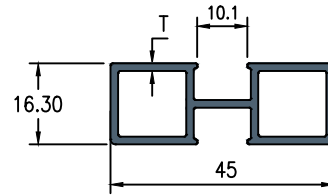

N0.	SECTION NO.	W	H	T	WEIGHT KG/12'
1	HD - 11650	45.00	16.30	1.54	2.000 - 2.200

HORIZONTAL FRAME

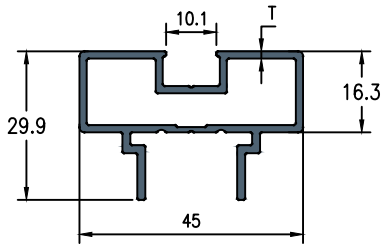

N0.	SECTION NO.	W	H	T	WEIGHT KG/12'
1	HD - 11655	45.00	16.30	1.45	2.300 - 2.600