

PARTITIONS

SINGLE PARTITION

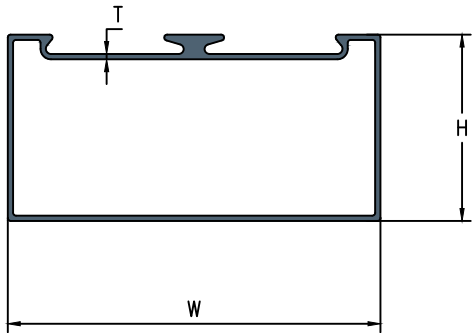

N0.	SECTION NO.	W	H	T	WEIGHT KG/12'
1	HD - 10250	50.00	25.00	0.71	1.200 - 1.400
2	HD - 10254	50.00	25.00	1.55	2.400 - 2.600
3	HD - 10300	63.00	38.00	0.75	1.700 - 1.900
4	HD - 10301	63.00	38.00	0.95	2.000 - 2.200
5	HD - 10303	63.00	38.00	1.03	2.100 - 2.300
6	HD - 10304	63.00	38.00	1.23	2.500 - 2.700
7	HD - 10305	63.00	38.00	1.40	2.900 - 3.200
8	HD - 10315	101.00	44.50	1.35	4.000 - 4.400

DOUBLE PARTITION

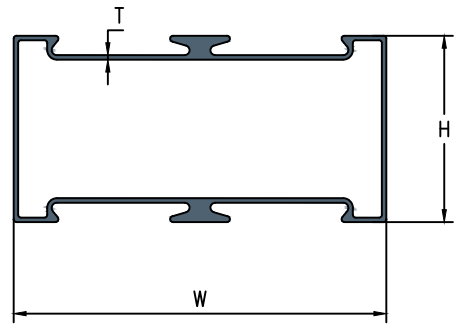

N0.	SECTION NO.	W	H	T	WEIGHT KG/12'
1	HD - 10260	50.00	25.00	0.60	1.200 - 1.400
2	HD - 10264	50.00	25.00	1.48	2.400 - 2.600
3	HD - 10330	63.00	38.00	0.85	2.200 - 2.400
4	HD - 10330.1	63.00	38.00	0.75	1.800 - 2.000
5	HD - 10331	63.00	38.00	0.65	1.600 - 1.800
6	HD - 10333	63.00	38.00	1.03	2.400 - 2.600
7	HD - 10334	63.00	38.00	1.23	2.800 - 3.200
8	HD - 10335	63.00	38.00	1.33	2.800 - 3.200
9	HD - 10350	101.00	44.50	1.26	3.900 - 4.300

PARTITIONS

DOOR TOP

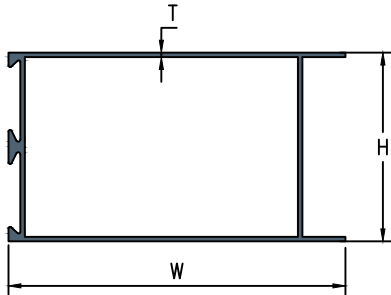

N0.	SECTION NO.	W	H	T	WEIGHT KG/12'
1	HD - 10410	47.50	44.50	1.05	2.000 - 2.200
2	HD - 10411	47.50	44.50	1.25	2.500 - 2.700
3	HD - 10415	85.00	44.50	1.35	3.600 - 3.900
4	HD - 10416	85.00	44.50	1.70	4.400 - 4.800

DOOR VERTICAL

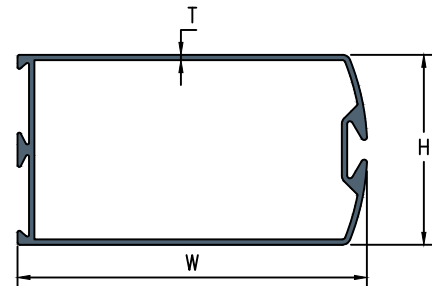

N0.	SECTION NO.	W	H	T	WEIGHT KG/12'
1	HD - 10420	47.50	44.50	1.05	2.300 - 2.500
2	HD - 10421	47.50	44.50	1.25	2.600 - 2.800
3	HD - 10425	85.00	44.50	1.30	3.700 - 4.000
4	HD - 10427	85.00	44.50	1.60	4.400 - 4.900

CORNER PARTITION

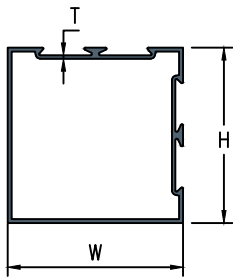

N0.	SECTION NO.	W	H	T	WEIGHT KG/12'
1	HD - 10390	63.50	63.50	1.42	3.700 - 4.000

PROFILE SAMOSA

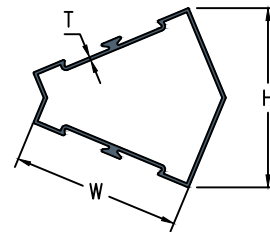

N0.	SECTION NO.	W	H	T	WEIGHT KG/12'
1	HD - 10430	67.00	63	1.28	3.000 - 3.300

TIPS VERTICAL

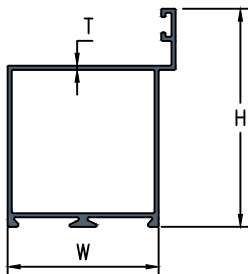

N0.	SECTION NO.	W	H	T	WEIGHT KG/12'
1	HD - 10403	49.50	64.30	1.20	2.700 - 2.900

LEG PARTITION

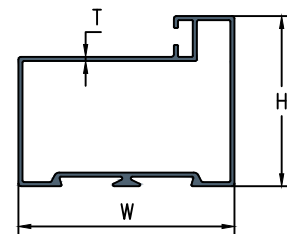

N0.	SECTION NO.	W	H	T	WEIGHT KG/12'
1	HD - 10465	63.50	50.00	1.20	3.000 - 3.300

PARTITIONS

DOOR MIDDLE SINGLE

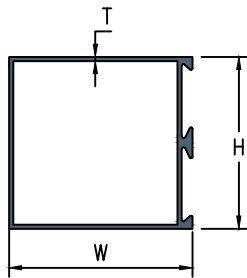

N0.	SECTION NO.	W	H	T	WEIGHT KG/12'
1	HD - 10360	47.50	44.50	1.08	2.100 - 2.300
2	HD - 10361	47.50	44.50	1.40	2.600 - 2.900

DOOR MIDDLE DOUBLE

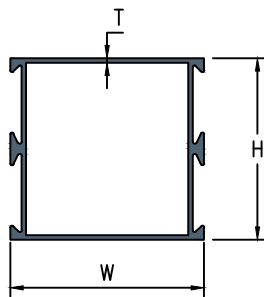

N0.	SECTION NO.	W	H	T	WEIGHT KG/12'
1	HD - 10400	47.50	44.50	1.10	2.300 - 2.500
2	HD - 10401	47.50	44.50	1.40	2.800 - 3.000
3	HD - 10405	85.00	44.50	1.30	3.700 - 4.100

2X1 P PIPE

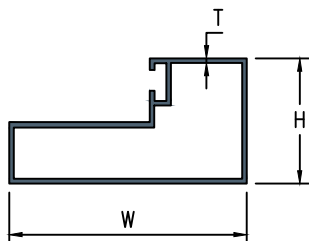

N0.	SECTION NO.	W	H	T	WEIGHT KG/12'
1	HD - 12000	46.50	24.50	0.90	1.200 - 1.400
2	HD - 12001	46.50	24.50	1.00	1.400 - 1.600

DOOR BOTTOM

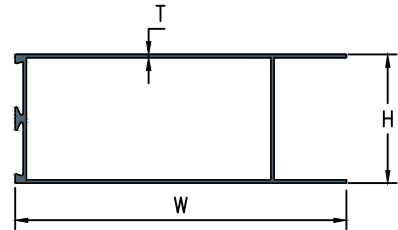

N0.	SECTION NO.	W	H	T	WEIGHT KG/12'
1	HD - 10435	114.50	44.50	1.15	3.800 - 4.200
2	HD - 10436	114.50	44.50	1.35	4.400 - 4.800

GLAZING PLATE

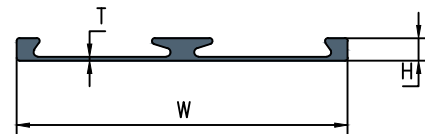

N0.	SECTION NO.	W	H	T	WEIGHT KG/12'
1	HD - 10460	44.40	3.00	0.50	0.500 - 0.600

1.5X1 L PIPE

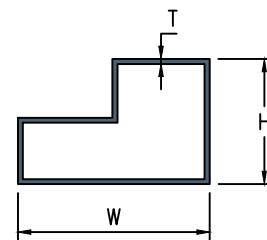

N0.	SECTION NO.	W	H	T	WEIGHT KG/12'
1	HD - 11119	37.50	24.50	0.88	1.000 - 1.100
2	HD - 11120	37.50	24.50	1.00	1.200 - 1.400
3	HD - 11121	37.50	24.50	1.10	1.200 - 1.400

PARTITIONS

GLAZING CLIP

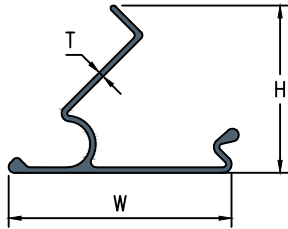

N0.	SECTION NO.	W	H	T	WEIGHT KG/12'
1	HD - 10440.1	20.20	15.20	0.45	0.200 - 0.230
2	HD - 10440.2	20.00	15.00	0.50	0.240 - 0.260
3	HD - 10442	20.20	15.20	0.60	0.270 - 0.300
4	HD - 10443	20.20	15.20	0.70	0.300 - 0.350

BOX CLIP

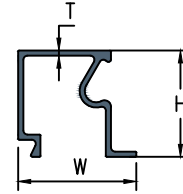

N0.	SECTION NO.	W	H	T	WEIGHT KG/12'
1	HD - 10450	19.10	17.20	1.31	0.700 - 0.900