

N0.	SECTION NO.	W	H	T	WEIGHT KG/12'
1	HD-55500	65.00	55.00	2.00	5.700 - 8.200

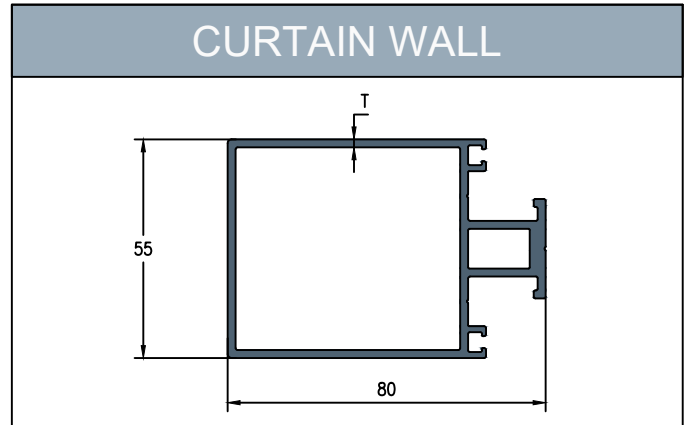

N0.	SECTION NO.	W	H	T	WEIGHT KG/12'
1	HD-55505	80.00	55.00	2.00	6.100 - 6.600

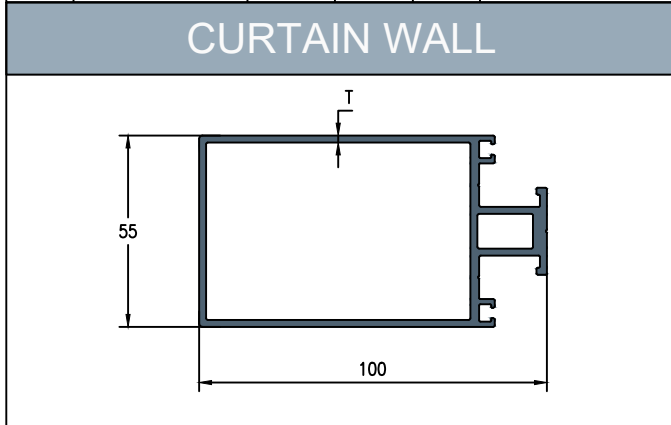

N0.	SECTION NO.	W	H	T	WEIGHT KG/12'
1	HD-55510	100.00	55.00	2.00	7.100 - 7.600

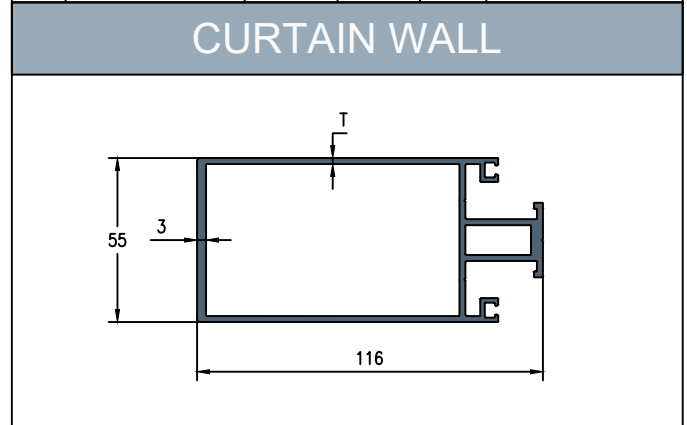

N0.	SECTION NO.	W	H	T	WEIGHT KG/12'
1	HD-55515	116.00	55.00	2.00	8.500 - 9.000

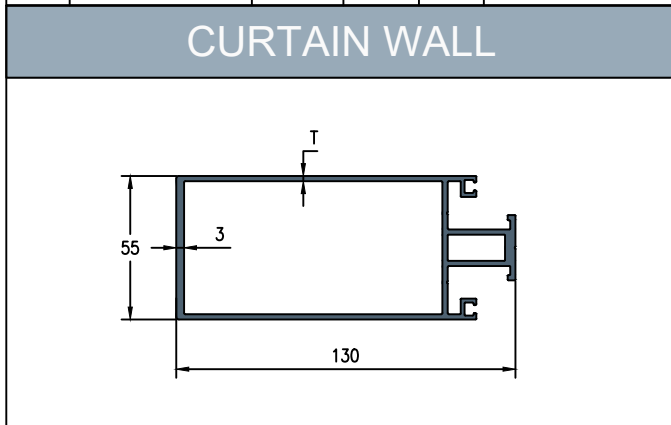

N0.	SECTION NO.	W	H	T	WEIGHT KG/12'
1	HD-55520	130.00	55.00	2.00	9.000 - 9.500

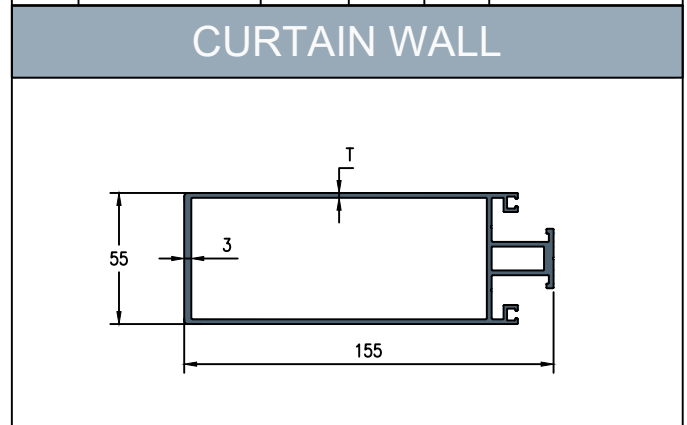

N0.	SECTION NO.	W	H	T	WEIGHT KG/12'
1	HD-55525	155.00	55.00	2.00	10.000 - 11.000

SPACER PLATE

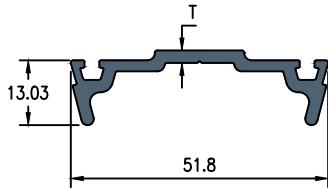

NO.	SECTION NO.	W	H	T	WEIGHT KG/12'
1	HD-55530	51.80	13.03	2.50	1.900 - 2.100

SASH

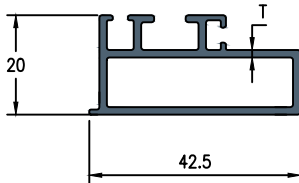

NO.	SECTION NO.	W	H	T	WEIGHT KG/12'
1	HD-55545	42.50	20.00	1.50	1.950 - 2.150

SASH

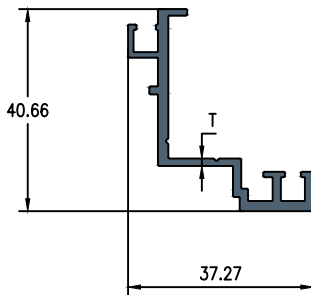

NO.	SECTION NO.	W	H	T	WEIGHT KG/12'
1	HD-55550	37.27	40.66	1.50	1.700 - 1.900

COVER PLATE

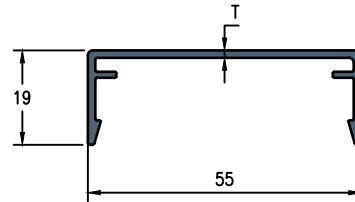

NO.	SECTION NO.	W	H	T	WEIGHT KG/12'
1	HD-55535	55.00	19.00	1.50	1.450 - 1.650

SASH

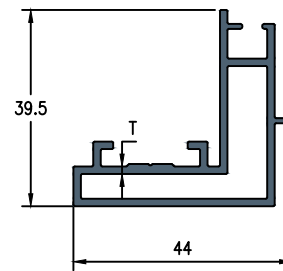

NO.	SECTION NO.	W	H	T	WEIGHT KG/12'
1	HD-55540	44.00	39.50	1.50	2.550 - 2.750

CURTAIN WALL

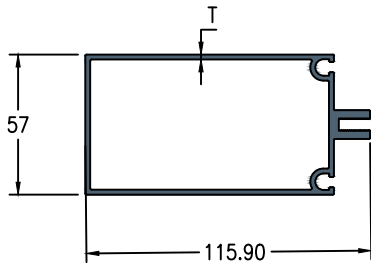

N0.	SECTION NO.	W	H	T	WEIGHT KG/12'
1	HD - 55710	115.90	57.00	2.00	7.500 - 8.000

CURTAIN WALL

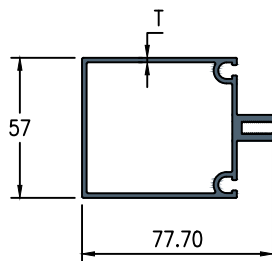

N0.	SECTION NO.	W	H	T	WEIGHT KG/12'
1	HD - 55700	77.70	57.00	1.85	5.500 - 6.000

COVER PLATE

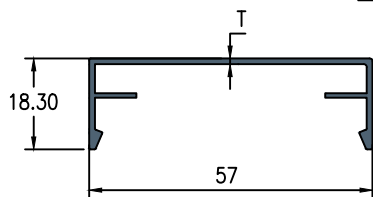

N0.	SECTION NO.	W	H	T	WEIGHT KG/12'
1	HD - 55730	57.00	18.30	1.15	1.200 - 1.400

HALF MULLION

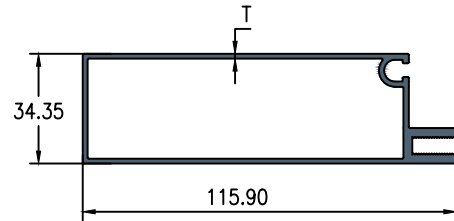

N0.	SECTION NO.	W	H	T	WEIGHT KG/12'
1	HD - 55715	115.90	34.35	1.80	5.900 - 6.400

SPACER PLATE

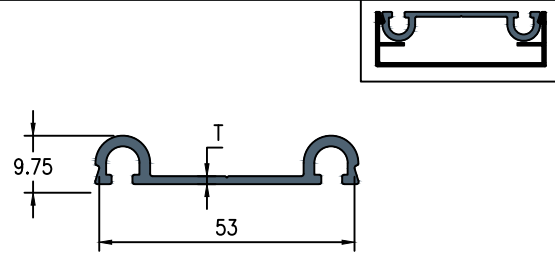

N0.	SECTION NO.	W	H	T	WEIGHT KG/12'
1	HD - 55720	53.00	9.75	1.60	1.500 - 1.700

57MM SASH

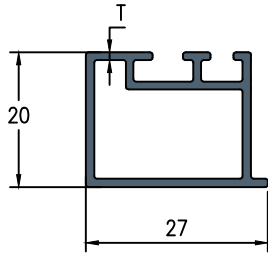

N0.	SECTION NO.	W	H	T	WEIGHT KG/12'
1	HD - 55760	27.00	20.00	1.25	1.200 - 1.400

57MM TONGLE

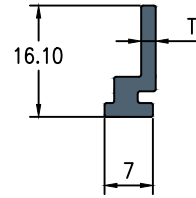

N0.	SECTION NO.	W	H	T	WEIGHT KG/12'
1	HD - 55765	7.00	16.10	2.10	0.500 - 0.700

CURTAIN WALL

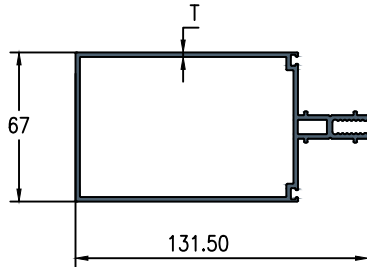

N0.	SECTION NO.	W	H	T	WEIGHT KG/12'
1	HD - 56710	131.50	67.00	2.00	8.100 - 8.600

HALF MULLION

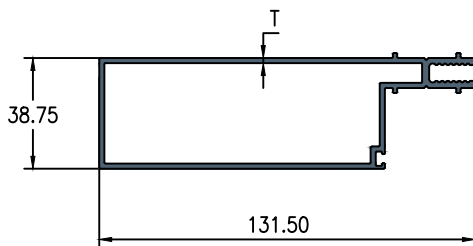

N0.	SECTION NO.	W	H	T	WEIGHT KG/12'
1	HD - 56720	131.50	38.75	1.80	6.200 - 6.700

CURTAIN WALL

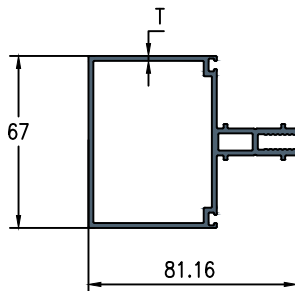

N0.	SECTION NO.	W	H	T	WEIGHT KG/12'
1	HD - 56700	81.16	67.00	1.90	5.900 - 6.400

CURTAIN WALL

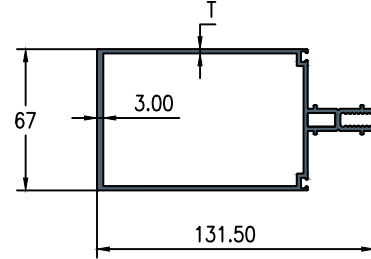

N0.	SECTION NO.	W	H	T	WEIGHT KG/12'
1	HD - 56711	131.50	67.00	2.00	8.700 - 9.200

CURTAIN WALL

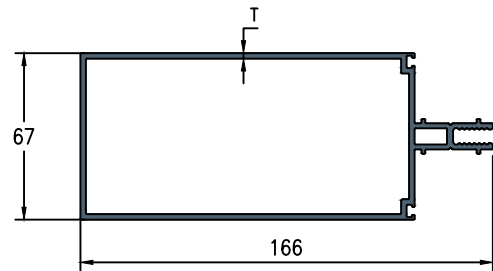

N0.	SECTION NO.	W	H	T	WEIGHT KG/12'
1	HD - 56712	166.00	67.00	2.20	10.200 - 10.800

HALF MULLION

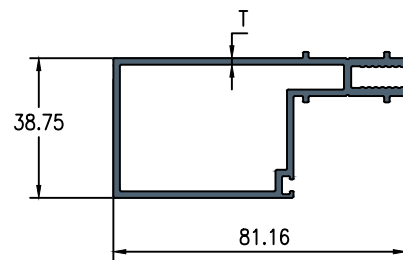

N0.	SECTION NO.	W	H	T	WEIGHT KG/12'
1	HD - 56715	81.16	38.75	1.80	4.400 - 4.800

SPACER PLATE

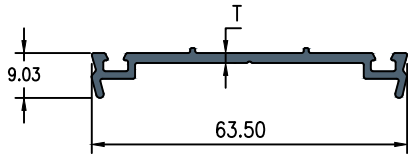

N0.	SECTION NO.	W	H	T	WEIGHT KG/12'
1	HD - 56725	63.50	9.03	2.00	1.550 - 1.750

67MM SASH

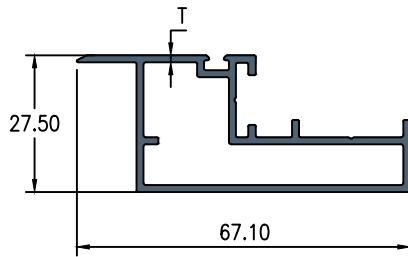

N0.	SECTION NO.	W	H	T	WEIGHT KG/12'
1	HD - 56735	67.10	27.50	1.40	2.700 - 2.900

67MM SASH

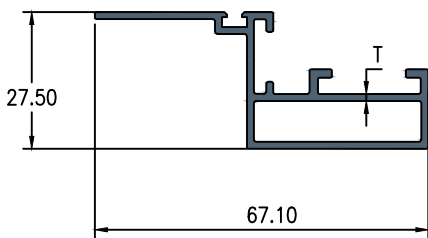

N0.	SECTION NO.	W	H	T	WEIGHT KG/12'
1	HD - 56745	67.10	27.50	1.40	2.300 - 2.500

COVER PLATE

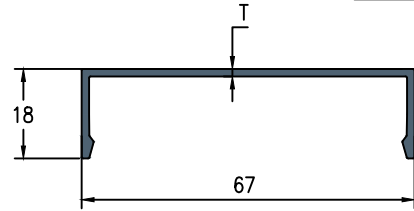

N0.	SECTION NO.	W	H	T	WEIGHT KG/12'
1	HD - 56730	67.00	18.00	1.50	1.500 - 1.700

67MM SASH

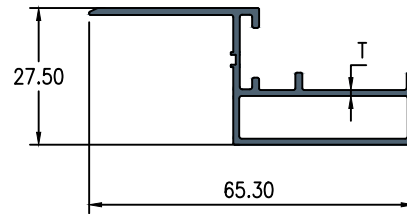

N0.	SECTION NO.	W	H	T	WEIGHT KG/12'
1	HD - 56740	65.30	27.50	1.20	1.900 - 2.100

67MM SASH

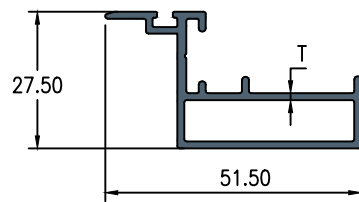

N0.	SECTION NO.	W	H	T	WEIGHT KG/12'
1	HD - 56750	51.50	27.50	1.40	2.000 - 2.200

67MM TONGLE

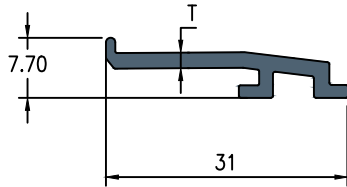

NO.	SECTION NO.	W	H	T	WEIGHT KG/12'
1	HD - 56755	31.00	7.70	2.00	0.700 - 0.900